

Decomposition of Cubic Graphs

on the Torus and Klein Bottle

by

Anna Caroline Bachstein

December 2015

A Thesis

Presented to the Faculty of the Department of Mathematical Sciences

Middle Tennessee State University

In Partial Fulfillment

of the Requirements for the Degree

Master of Science in Mathematical Sciences

Thesis Committee:

Dr. Dong Ye, Chair

Dr. Xiaoya Zha

Dr. Chris Stephens

This thesis is dedicated to my parents, who has taught me, encouraged me and supported me in my life. Thanks for all your patience, love and unconditional support.

ACKNOWLEDGMENTS

This thesis would not have been possible without Dr. Dong Ye, whose patience and guidance from the beginning allowed me to complete this project. Also thank you to the GTA's of the Mathematics Department of Middle Tennessee State University for putting up with me and my craziness while completing this project.

ABSTRACT

It was conjectured by Hoffman-Ostenhof that the edge set of every cubic graph can be decomposed into a spanning tree, a matching, and a family of cycles. This conjecture was verified for many graphs such as the Peterson graph, prisms over cycles, and Hamiltonian graphs. Later the conjecture was also verified for 3-connected cubic graphs on the plane and protective plane by Kenta Ozeki and Dong Ye. In this paper we will verify the conjecture for 3-connected cubic graph on the torus and Klein bottle.

TABLE OF CONTENTS

LIST OF FIGURES	v
CHAPTER 1: INTRODUCTION	1
1.1 Definitions	1
1.2 Background	5
CHAPTER 2: MAIN THEOREM	9
2.1 Cutting the Surfaces	9
2.2 Minimum Counterexamples	13
2.3 A Technical Lemma	15
CHAPTER 3: FUTURE RESEARCH	30
3.1 HIST Decomposition	30
3.2 Other Surfaces	31
BIBLIOGRAPHY	32

LIST OF FIGURES

1	This graph is disconnected because of vertex 6. However the graph is simple.	2
2	Both of the later two graphs demonstrate a spanning trees of the original graph to the left	3
3	An example of a decomposition of K_4 into $K_{1,3}$ and a triangle K_3 . . .	3
4	Here is an example of a torus, licensed under Public Domain via Commons, to the left and a Klein bottle, licensed under CC BY-SA 3.0 via Commons, to the right.	5
5	The decomposition of Peterson's Graph	7
6	Here we have an example what a component Q might look like. . . .	10
7	This Klein bottle is drawn with boundaries AB and CD	11
8	Here is the Klein bottle with its boundary shifted so Q is no longer disconnected.	12
9	The decomposition of triangles	15
10	To the left is a simple example of Case 1 and to the right is an example of Case 2	17
11	In the second graph the red line shows where we placed the edges in the matching and now have one boundary.	19
12	The first graph is an example of G with all tree-attachments on one boundary. The second graph where we placed edge e in the matching.	19
13	For the case of alternating tree-attachments, the red highlighted edges are the edges where we have a degree of choice. In this case the yellow edge is the one that can be placed in the matching.	20

14	This is an example of how we would contract the edges and which edges belong to the matching.	24
15	Example of a block with one face with and with out the matching . .	26
16	The yellow edges indicate the original 2-edge-cut that has no tree attachments. The red edges show the edges that are placed in the matching from Q_i . The green edge corresponds to the red edges when Q_i in contracted to Q'_1	27
17	Here the red vertices show the new degree two vertices. Note that the green are not new degree two vertices. The green vertices indicate tree-attachments, or a chain of vertices that can be contracted to a tree-attachment.	28
18	This graph shows an example a block with all tree-attachments on one side. The red edge indicates an edge joining two tree attachments. . .	28
19	This is an example of a block with alternating tree attachments. The red edge is an edge connecting two tree-attachments, furthermore we can place that edge into the matching. Note that we also could have chosen the green edge.	29

CHAPTER 1

INTRODUCTION

1.1 Definitions

First we will go over some basic graph theory definitions that we will see throughout the paper.

A *graph* G consists of a set $E(G)$ whose elements are edges of the graph and a set $V(G)$ whose elements are vertices of G . A *walk* in a graph is sequence of alternating vertices and edges, beginning and ending with vertices, where each edge's endpoints are the preceding and following vertices in the sequence. So a *cycle* is a walk which, without repeating edges, ends at the same vertex which it begins and a *path* is a walk, without repeating edges, but does not end at the same vertex. So we have that an edge is a cut edge if and only if the edge is not contained in any cycle. A *tree* is graph with no cycles or acyclic. A *spanning tree* is a subgraph of G which contains all vertices of G and is acyclic. A graph G is *connected* if for any two vertices of G , there is path joining them. For instance we can have a graph that is consist of three vertices and one edge. Then one vertex will not be connected, or *disconnected*, to any other vertex. If a part of G is disconnected then G has *components*. For example if G is disconnected into 2 parts then G has two components.

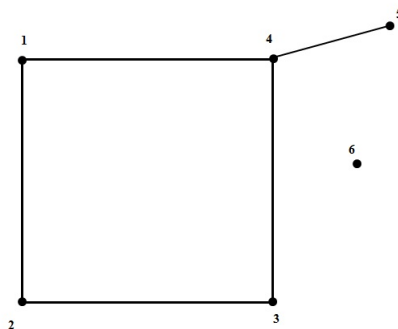

Figure 1: This graph is disconnected because of vertex 6. However the graph is simple.

All graphs in this paper are *simple* and *connected*, which means that between any vertex there is at most one edge. We start off with a *3-edge-connected graph*, which means that we will have to delete a minimum of 3 edges to to disconnected the graph. In other words we can delete 2 edges and the graph still be connected. Similarly *3-vertex-connected* means we can remove 2 vertices and the graph will be still connected. A *subgraph* H , of a graph, G , is a graph whose vertices are a subset of the vertex set of G , and whose edges are a subset of the edge set of G .

A vertex *incident* with an edge if it is an endpoint of the edge. For example if $v_1, v_2 \in V(G)$ such that an edge $e \in E(G)$ connects v_1 to v_2 then both v_1 and v_2 are incident with e moreover we can define $e = v_1v_2$. Similarly two edges are *adjacent* if they share a vertex. The *degree* of the vertex is the number of edges that are incident with each vertex. So a graph is called *cubic* if every vertex has degree 3. A *bridge* or a *cut-edge* is an edge whose deletion increases the number of connected components.

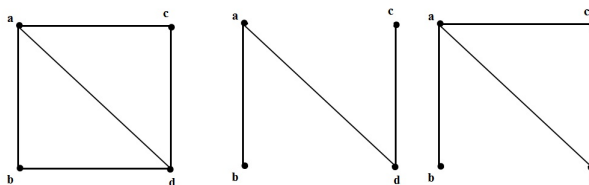

Figure 2: Both of the later two graphs demonstrate a spanning trees of the original graph to the left

A *decomposition* of G consists of edge disjoint subsets whose union is G . Note that union of graphs is with respect to their respective vertex and edge set. A *matching* is set of edge disjoint edges. For two edges to be disjoint, one edge is not adjacent with the other edge. A *perfect matching*, sometimes called a *1-factor*, means that every vertex of the graph is incident to exactly one edge of the matching. A *2-factor* is a collection of cycles that spans all vertices of the graph.

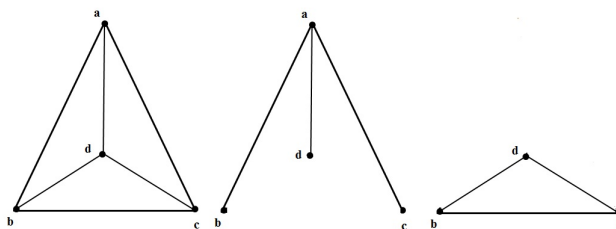

Figure 3: An example of a decomposition of K_4 into $K_{1,3}$ and a triangle K_3

A graph can be called K_n if it is a complete graph. In other words every vertex is connected to every other vertex. The "n" part of is the number of vertices the graph has. A graph can be called $K_{m,n}$ if it is a complete bipartite graph. So one part has m vertices that is connected every vertex of the part that has n vertices and there are

no odd cycles. For example in Figure 3, the middle graph is $K_{1,3}$ so vertex a is the 1 vertex connected to the 3 vertices $\{b, d, c\}$, however $\{b, c, d\}$ are not connected to each other.

Now we will look at some topology and definitions regarding the surface of the graph we are dealing with.

A graph is called *planar* if it can be drawn on the Euclidean plane, a flat piece of paper, such that none of the graph's edges cross. For example the graph K_4 is planar, however the graph $K_{3,3}$ is not planar. To *embed* a graph into a plane means we draw the graph on the plane with no edges crossing. So a planar graph is a graph embedded in the Euclidean plane. Note that while $K_{3,3}$ is not planar, $K_{3,3}$ can be drawn into a torus with no edges crossing.

A *torus* is a surface or solid formed by rotating a closed curve, especially a circle around a line that lies in the same plane but does not intersect it. An ordinary torus, which is what we looking at in this paper usually it is described as a doughnut. Also an ordinary torus is a surface of genus one. A *genus* of a connected, orientable surface is an integer representing the maximum number of cuttings along non-intersecting closed simple curves without rendering the resultant manifold disconnected. For example, an object of genus zero is a sphere. However the definition of a genus changes for non-orientable surfaces. In layman terms an orientable surface is a surface where you can consistently make a direction for a circle and it will always go in that direction. In other words you make a circle go clockwise and wherever it is on the surface it will still go clockwise. A non orientable surface means you cannot chose a direction for a loop and consistently stay going that direction. A Klein bottle is an example of a non orientable surface. A *Klein bottle* is a closed surface with only one side, formed by passing one end of a tube through the side of the tube and joining it to the other

end. To have a cycle embedded on a graph to be *non-contractible* means that the cycle cannot be continuously shrunk to one point. A *non-separating* is a cycle that when taken out does not separate the graph or the surface into two parts.

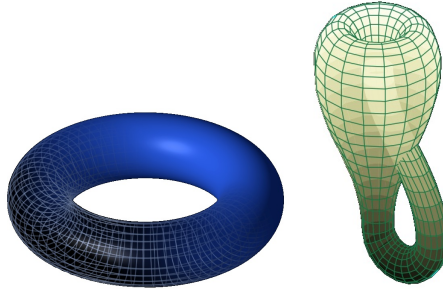

Figure 4: Here is an example of a torus, licensed under Public Domain via Commons, to the left and a Klein bottle, licensed under CC BY-SA 3.0 via Commons, to the right.

1.2 Background

There has been many results for decomposing graphs into certain subgraphs. In particular as it applies to graph coloring. Many interesting problems can be formulated as a decomposition problem of a graph. For example Carsten Thomassen proposed the following well-know conjecture.

Conjecture 1.1 [14] *Every cyclically 4-edge-connected cubic graph has a dominate cycle.*

This conjecture is the same as saying that every 4-edge-connected cubic graph has a decomposition into a cycle and a forest with components isomorphic to $K_{1,3}$ and K_2 . As a consequence of Thomassen's result [15] the above conjecture holds for plane

4-edge-connected cubic graphs. Another interesting question on the decomposition of cubic graphs is the following conjecture proposed by Mazzuocolo [11], which is closely related to the well known Berge-Fulkerson Conjecture, which proposes that any bridgeless cubic graph has six perfect matchings such that each edge is in exactly two.

Conjecture 1.2 [11] *For every bridgeless cubic graph, there are two perfect matchings such that the complement of their union is a bipartite graph.*

Which in terms of decomposing graphs, Conjecture 1.2 says that every bridgeless cubic graph can be decomposed into a bipartite, a matching, and a family of even cycles.

Balogh, Kochol, Pluhar, and Yu [3] proved that every plane graph has a decomposition into 3 forest and one of them has maximum degree 8. Further more they derived upper bounds on the game chromatic number and the game coloring number of planar graphs with girth conditions. Goncalves [5] proved a conjecture by Balogh, et al ..., that every plane graph can be decomposed into 3 forest and one of them has max degree 4. There are also solved problems with certain decomposition with spares graphs.

How about the decomposition of cubic graphs into certain subgraphs? We already have Thomassen's result [15] for a 4-edge-connected cubic graphs. Note though, a cubic graph does not have a decomposition into a forest and a matching because of degree condition, however the Peterson Theorem implies that a 2-connected cubic graph has a decomposition into a forest and a family of cycles. However instead of forest we can look at spanning tress, in particular a homeomorphically irreducible spanning tree (HIST). A spanning tree is a HIST if it does not contain a vertex of

degree two [7]. Hoffmann-Ostenhof and Ozeki provided the necessary condition for the existence of a HIST in cubic [7], however Douglas proved that it is NP-complete to determine whether a plane cubic graph has a HIST [4].

Going in a slightly different direction, Malkevitch asked which 3-connected plane cubic graphs have a decomposition into a spanning tree and a family of cycles [10]. Later Lemke proved that it is NP-complete to determine whether a given cubic graph has the decomposition or not [9]. Furthermore the following is a conjecture by Hoffman - Ostenhof [6]

Conjecture 1.3 *Let G be a connected cubic graph. Then G has a decomposition into a spanning tree, a matching, and a family of cycle.*

This conjecture was verified to be true for many graphs such as Peterson graph, prisms over cycles, and Hamiltonian graphs [2]. Below is an example of a decomposition of Peterson graph, where the yellow edges are the edges placed in either a cycle or a matching.

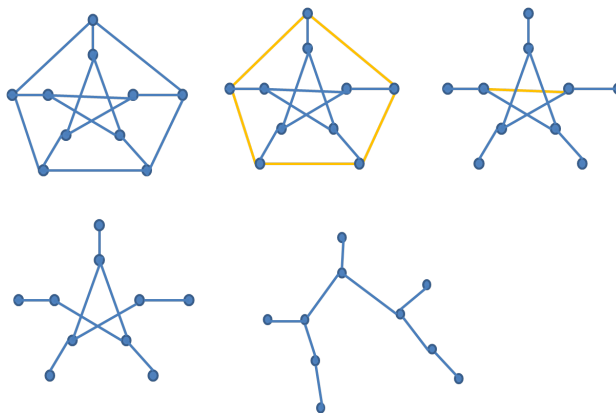

Figure 5: The decomposition of Peterson's Graph

In particular Ozeki and Ye proved the conjecture true for 3-connected plane graphs and projective plane graphs [13].

Theorem 1.4 [13] *Let G be a 3-connected cubic graph embedded in the plane or projective plane. Then G has a decomposition into a spanning tree, a matching and a family of cycles.*

The above theorem serves as the departure point of this thesis. The following is our major result.

Theorem 1.5 *Let G be a 3-connected cubic graph embedded in the Torus or Klein-bottle. Then G has a decomposition into a spanning tree, a matching, and a family of cycles.*

In the next chapter, we will prove main theorem and discuss further interesting problems.

CHAPTER 2

MAIN THEOREM

We will denote the outer boundary of our graph as ∂_2 and the inner boundary of the graph as ∂_1 . A face f is said to be *boundary adjacent* face if f shares at least one edge with either boundary and $f \neq \partial_1$ or ∂_2 . A face f is called *2-boundary-adjacent* if f shares an edge with both boundaries. A vertex of degree one is called a *leaf*. A vertex v is called a *tree-attachment* if v is incident with a cut edge e such that $G - e$ has two components, where one of them contains v . A *block* B is a minimal subgraph separated by a 2-edge-cut $S \subseteq \partial_1 \cup \partial_2$ such that B is a connected component of $G - S$.

We will restate Richter and Vitvary [16] proposition in terms more fitting with our Lemma in the next section.

2.1 Cutting the Surfaces

Proposition 2.6 [16] *Let G be a 2-connected graph embedded in a surface Σ . Either G contains a non-contractible cycle or G is planar.*

Lemma 2.7 *Let G be a 3-connected toroidal cubic graph. Then G has a non-contractible non-separating cycle.*

Proof of Lemma By the above proposition, G contains a non-contractible cycle. If G contains a non-contractible non-separating cycle, then we are done. So assume that every non-contractible cycle is separating. Choose C to be a such cycle that $G - E(C)$ has the smallest number of components. Let Q_1, Q_2, \dots, Q_k be the components of $G - E(C)$.

If one of these components is contained in an open disc D of the torus Σ , say Q_1 , let v_1, \dots, v_α ($\alpha \geq 3$) be the attachments of Q_1 on C in clockwise order. Let P be path of Q_1 joining v_1 and v_α such that P together with a segment S from C joining v_1 and v_α together bound a disc containing Q_1 . Let $C' := (C - S) + P$. Since $P \cup S$ is a contractible cycle, then C' is non-contractible.

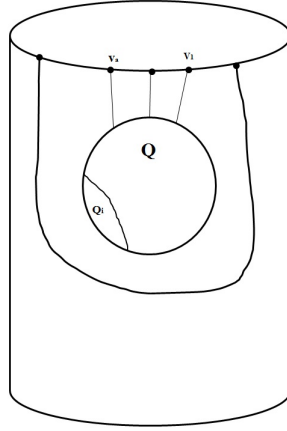

Figure 6: Here we have an example what a component Q might look like.

Claim: The number of components of $G - E(C')$ is less than the number of components of $G - E(C)$.

Proof of Claim. Note that the segment S contains attachments of Q_i for some $i \neq 1$. Otherwise, the edges from $C \cap C'$ incident with v_1 and v_α form a 2-edge-cut separating $Q_1 \cup S$ from the remaining subgraph, a contradiction to 3-connectivity of G . So $(Q_1 \cup S) - E(P)$ is connected, then Q_i and $(Q_1 \cup S) - E(P)$ will be a connected component, and hence then number of components of $G - E(C')$ is reduced by 1. So the claim follows. Therefore we may assume that $(Q_1 \cup S) - E(P)$ is not connected. Then $(Q_1 \cup S) - E(P)$ has a component with all attachments u_1, \dots, u_β on P in

clockwise order. Let S' be the segment of P from u_1 to u_β . So the two edges incident with u_1 and u_β from $P - E(S')$ form a 2-edge-cut, a contradiction to the 3-connectivity of G . The contradiction completes the proof of the claim. \square

By the choice of C and Claim, we can conclude that none of these components Q_i is contained in an open disc of Σ . Then Q_1 intersects the left neighborhood of C and also the right neighborhood of C . Let v_1, \dots, v_α be the attachments of Q_1 on C in clockwise order. Note that the segment S of C from v_1 to v_α ($\alpha \geq 3$) containing all attachments of Q_1 does not contain attachments of other component Q_i . Then the two edges incident with v_1 and v_α from $C - E(S)$ form a 2-edge-cut of G , a contradiction. This completes the proof.

Lemma 2.8 *Let G be a 3-connected Klein-bottle cubic graph. Then G has a non-contractible non-separating cycle C .*

Let AB and CD be the boundary of the Klein-bottle such that they both are going in the same direction. Then boundary AD is in opposite direction from BC . Let vertices x and y be in the embedded graph G such that the edge xy crosses AB and CD .

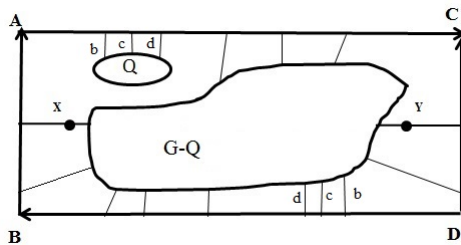

Figure 7: This Klein bottle is drawn with boundaries AB and CD

Proof of Lemma: Let E_0 be the edges crossing the boundary. Then choose an embedding of G such that E_0 is minimal. Then $G - E_0$ is connected.

If $G - E_0$ is not connected then let Q be a component of $G - E_0$. Then Q has some edges say b, c, d that, with out loss of generality, cross AD . Then we can shift the boundary until the edges b, c, d do not cross AD , then call this E'_0 . However $|E'_0| < |E_0|$ since b, c, d no longer cross the boundary. So E'_0 is smaller than E_0 a contradiction to E_0 is minimum. Therefore $G - E_0$ is connected.

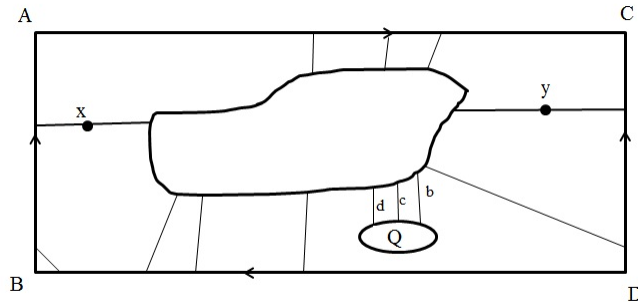

Figure 8: Here is the Klein bottle with its boundary shifted so Q is no longer disconnected.

Since $G - E_0$ is connected there is a path P joining x and y in $G - E_0$. Then $P + xy$ is a non-contractible cycle crossing the boundary once. Now choose one of such cycles C such that

- (1) $G - E(C)$ has minimum number of components
- (2) the smallest component of $G - E(C)$ is as small as possible

Claim: $G - E(C)$ is connected.

Proof of Claim: If not, choose the smallest component Q of $G - E(C)$. Since G is 3-connected, there is at least 3 attachments of Q on C in order x_1, x_2, \dots, x_k . Then there are edges joining the vertices in the segment S of C containing x_1, x_2, \dots, x_k to $G - E(C) - Q$, otherwise $\{x_1, x_2\}$ is a 2-edge-cut separating $S \cup Q$ from the remaining subgraph a contradiction to the 3-connectivity of G . Let K be the path of Q joining x_1 and x_k such that K together S that bound a disk containing Q . Let now we can find a new cycle C' such that $C' = (C - S) + K$. Since $K \cup S$ is non contractible, then C' is non contractible.

Then we have that $(Q \cup S) - E(K)$ is connected. Then Q and $(Q \cup S) - E(K)$ will be a connected component, therefore the number of components of $G - E(C')$ will be reduced by 1. Then the claim follows.

So assume $(Q \cup S) - E(K)$ is no connected. Then $(Q \cup S) - E(K)$ has a component with all attachments in order u_1, u_2, \dots, u_m on K . Let S' be the segment of K from u_1 to u_m . Then the two edges incident with u_1 and u_m from $K - E(S')$ form a 2-edge-cut, a contradiction to the 3-connectivity of G . Therefore $G - E(C)$ is connected. \square

2.2 Minimum Counterexamples

Let G be a connected cubic graph embedded on the torus. Assume that G is a minimum counterexample to Hoffman-Ostenhof's Conjecture 1.3.

Conjecture 1.3 *Let G be a connected cubic graph. Then G has a decomposition into a spanning tree, a matching, and a family of cycle.*

Then G does not have a decomposition into a spanning tree and cycles and a matching.

Lemma 2.9 *Let G be a minimum counterexample to Hoffman-Ostenhof's Conjecture. Then G is triangle-free.*

Proof of Lemma: Assume D is a triangle of G with $V(D) = \{v_1, v_2, v_3\}$ and let e_i be the edge incident with v_i but $e_i \notin E(D)$ ($i = 1, 2, 3$). Let G/D be the graph obtained from G by contracting all edges in D and deleting all loops. Then G/D is still a connected cubic graph, and let v be the new vertex corresponding to the contracted triangle D . Since G is a minimum counterexample, G/D is smaller than G and therefore is not a counterexample to the conjecture. So G/D has a decomposition $\{T', F', M'\}$. Note that $v \in T'$.

If v is a degree 3 vertex in T' , then let $T = (T' - v) \cup \{e_1, e_2, e_3\} \cup v_1v_2v_3$, $F = F'$ and $M = M' \cup \{v_2v_3\}$. Then $\{T, F, M\}$ is a decomposition of G , contradiction to that G is a counterexample.

If v is a degree 2 vertex in T' , without loss of generality, T' contains the edges e_1 and e_2 . Then let $T = (T' - v) \cup \{e_1, e_2\} \cup v_1v_3v_2$, $F = F'$ and $M = M' \cup \{v_2v_3\}$. Then $\{T, F, M\}$ is a decomposition of G , a contradiction.

So assume that v is a vertex of degree 1 in T' . Without loss of generality, say T' contains e_1 . Then e_2 and e_3 will be contained in a cycle $C' \in F'$. Then let $C = (C' - v) \cup \{e_2, e_3, v_2v_3\}$, which is a cycle of G . Let $T = (T' - v) \cup \{e, v_1v_2, v_1v_3\}$, $F = (F' \setminus \{C'\}) \cup \{C\}$ and $M = M'$. Again, $\{T, F, M\}$ is a desired decomposition of G , a contradiction, which completes the proof.

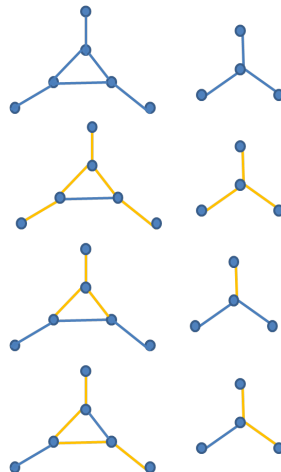

Figure 9: The decomposition of triangles

In the figure 9 the yellow edges represent the edges placed in the spanning tree, while the blue are the edges placed in the matching or cycle.

2.3 A Technical Lemma

By Lemma 2.7, a 3-connected cubic graph on the torus contains a non-contractible non-separating cycle C . So $G - E(C)$ is a planar graph with two faces which are not bounded by cycles. We may call the graph $G - E(C)$ is cylindrical. For convenience, the two face boundaries are also called the boundaries of the graph $G - E(C)$, denoted by ∂_1 and ∂_2 . Furthermore recall the definitions given in the last section, in particular tree-attachment, 2-boundary adjacent face, and a block. In the following, we are going to prove that $G - E(C)$ has a decomposition into a spanning tree T , a family of cycles H and a matching M . Note that many of the claims follow directly from Ozeki and Ye technical lemma, which is the following.

Lemma 2.10 [13] *Let G be a connected plane graph with maximum degree at most 3. Suppose that*

- (1) *all cut-edges of G are contained in ∂G , and*
- (2) *for all 2-edge-cuts S , both edges are contained in ∂G*

Then G has decomposition $\{T, M, H\}$ such that T is a spanning tree in G , M is matching and H is a family of facial cycles.

Note that Lemma 2.10 gives us a decomposition when we have one boundary, or in other words when $\partial_1 = \partial_2$. Generally, we prove the following technical lemma.

Lemma 2.11 *Let G be a connected plane graph with maximum degree at most 3. Assume that G has exactly two faces which are not bounded by cycles, and their boundaries are denoted by ∂_1 and ∂_2 . Suppose that*

- (1) *All cut edges appear on one of the two boundaries, ∂_1 and ∂_2 ;*
- (2) *For any 2-edge cut S , both edges in S are contained in ∂_1 or ∂_2 or both;*
- (3) *An edge incident with a vertex of degree at most 2 is either a cut-edge of G or on $\partial_1 \cap \partial_2$;*
- (4) *If $\partial_1 \cap \partial_2 \neq \emptyset$, then G contains a block or $\partial_1 \cap \partial_2$ contains two consecutive tree-attachments.*

Then, for any given 2-edge-cut $S = \{e_1, e_2\}$ of G , G has a decomposition $\{T, H, M\}$ such that T is a spanning tree containing e_1 , H is a family of facial cycles, and M is a matching containing e_2 .

So note we have two cases for G . Case 1 where we have $\partial_2 \cap \partial_1 = \emptyset$ and case 2 where we have $\partial_2 \cap \partial_1 \neq \emptyset$. Note that when we start decomposing case 1 we will eventually get case 2. When we get to case 2 we then can open up the graph so we have one boundary thus can use Lemma 2.10 to finish the decomposition. In general we decompose G for each case and show that we get a smaller graph that still satisfies the conditions in Lemma 2.11.

Case 1: $\partial_2 \cap \partial_1 = \emptyset$

If there are no 2-boundary adjacent faces then we without loss of generality we can start on ∂_2 and use Ozeki and Ye decomposition until we get where ∂_2 meets ∂_1 and then use Case 1. So assume there is at least one 2-boundary adjacent face.

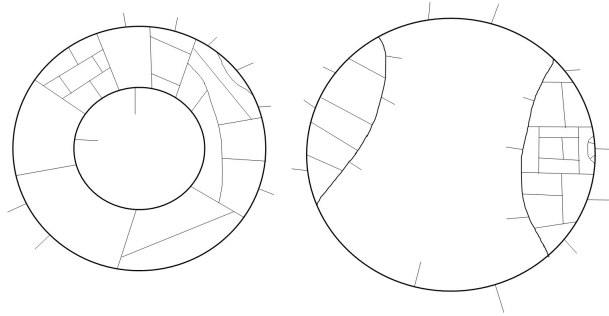

Figure 10: To the left is a simple example of Case 1 and to the right is an example of Case 2

Case 2: $\partial_2 \cap \partial_1 \neq \emptyset$

We must have at least one block in this case, if not the $\partial_2 \cap \partial_1$ is a cycle so we are done. So assume we have at least one block B . Furthermore in general all edges that lie on the intersection $\partial_2 \cap \partial_1$ will be contained in the spanning tree T . Later we will go over a special case of where this is not the case.

Remark. Let G be a graph as stated in Lemma 2.11, and let v be a vertex of degree-2. Then at least one of the edges incident with v must be contained in T . This implies that no cycle in f can pass through v and hence every facial cycle in f consists of edges joining two vertices of degree 3. Furthermore, if an edge incident with v is a cut edge, then it is easy to see that both of the edges incident with v are contained in T . Also note if G has no cycle then assume that the lemma does not hold and let G be a minimum counterexample with respect to $|V(G)| + |E(G)|$. If G has no cycle then we have $\{G, \emptyset, \emptyset\}$ as a decomposition.

Next we will introduce a small lemma that also serves as an example of both how the decomposition works and how we will prove by minimum counter example. In particular we will have a special case of G be from Case 1 where G has all two-boundary adjacent faces.

Lemma 2.12 *Let G be a graph satisfying (1)-(4) of Lemma 2.11 where every face is a 2-boundary adjacent face containing at least one tree-attachment. Then G has a decomposition into a spanning tree, a matching, and a family of cycles.*

Proof of Lemma: Let G be as described above and be a minimum counter example to Lemma. If G has at least one face that contain tree-attachments on both sides. Then let t_1 be the tree-attachment on ∂_1 and t_2 be the tree-attachment on ∂_2 . Then we can place an edge e_1 incident to t_1 and an edge e_2 incident to t_2 in a matching. Then since f was 2-boundary adjacent we now have that $\partial_1 = \partial_2$, therefore we can use Ozeki and Ye's Lemma 2.10 [13] to decompose $G - \{e_1, e_2\}$ into a spanning tree T , and matching M , and a family of cycles H . So the final decomposition of G is $\{T, M \cup \{e_1, e_2\}, H\}$ which is a contradiction to the fact that G was a minimum counterexample.

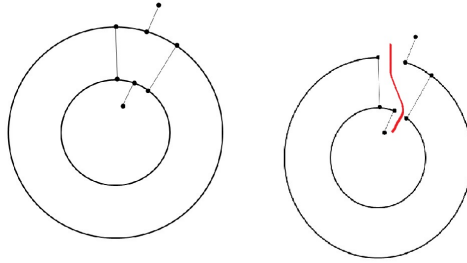

Figure 11: In the second graph the red line shows where we placed the edges in the matching and now have one boundary.

Now let G be such that all the tree-attachments are on one of the boundaries, say ∂_2 . Then we can place every other edge along ∂_2 into the matching M . Next we can pick any one edge say e on ∂_1 and place the edge into the matching. Now we have connected to two boundaries, therefore we use Lemma 2.10 [13] to decompose the graph with $\{T, M \cup \{e\}, H\}$. A contradiction to G being a minimum counterexample.

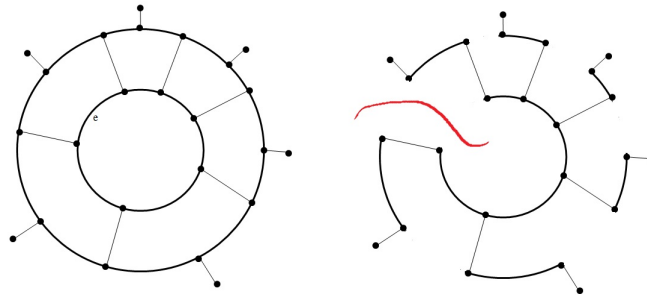

Figure 12: The first graph is an example of G with all tree-attachments on one boundary. The second graph where we placed edge e in the matching.

Now consider now consider when G has alternating tree-attachments on each boundary. Then with out loss of generality, consider ∂_2 first. Place every other edge that is

adjacent to a tree-attachment into the matching M . Similarly on ∂_1 we will place an edge adjacent to each tree-attachment in the matching. However G has alternating tree-attachments we can choose each edge next the tree-attachments on ∂_1 such that we have an edge e that is not adjacent to any edge in the matching. Now we have at least one edge e on ∂_2 can be placed into the matching. Now $\partial_1 = \partial_2$ so we can use Lemma 2.10 [13] to decompose the graph into a spanning tree T , a matching M' , and a family of cycles H . So we will have a final decomposition of $\{T, M \cup M' \cup \{e\}, H\}$. A contradiction to G being a minimum counterexample.

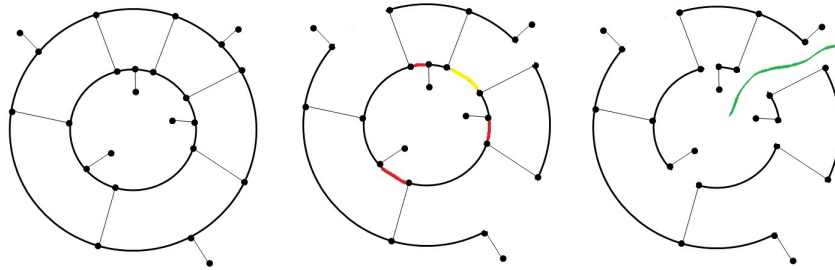

Figure 13: For the case of alternating tree-attachments, the red highlighted edges are the edges where we have a degree of choice. In this case the yellow edge is the one that can be placed in the matching.

Thus if G is a graph satisfying (1)-(4) of Lemma 2.11 where every face is a 2-boundary adjacent face containing at least one tree-attachment. The G has a decomposition into a spanning tree, a matching, and a family of cycles. \square

Now we are going to prove Lemma 2.11 through a use of several claims. Some claims can be generalized to both cases, so it will be remarked whether or note the claim has to do with a single case or both.

Proof of Lemma 2.11

Let G be a minimum counter example to Lemma 2.11. Now we will show several claims.

The following claim can be generalized to both cases.

Claim 1. The graph G does not contains a non-trivial cut-edge.

Proof of Claim 1. Suppose to the contrary that G or B has a cut-edge $e = v_1v_2$. Without loss of generality let us use B . Let D_1 and D_2 be components of $B - e$ such that $v_i \in D_i$ where $i = 1, 2$. Note that $|D_i| < |B|$ and D_i is a connected plane graph with maximum degree at most 3 and satisfies conditions (1)-(4). Since B is a minimum counterexample, D_i has a decomposition, say $\{T_i, M_i, H_i\}$. Then T is a spanning tree of B where $T = T_1 \cup T_2 \cup \{v_1v_2\}$. Moreover, $M_1 \cup M_2$ is a matching of G and $H_1 \cup H_2$ is a family of cycles of G . So G has the decomposition $\{T, M_1 \cup M_2, H_1 \cup H_2\}$, a contradiction. \square

The following claim can be generalized to bath cases.

Claim 2. If G has a boundary-adjacent facial cycle f , then f contains a 2-edge-cut of G .

Proof of Claim 2. Without loss of generality assume we are working with the graph G . Suppose to the contrary that there exists a boundary adjacent cycle F of G such that F does not contain a 2-edge-cut of G . Let $G' = G - E(F)$.

We first show that G' is connected. If not, let D'_1 and D'_2 be two components of G' . Let $D_1 = D'_1 - V(F)$ and $D_2 = D'_2 - V(F)$. If there is only one edge e_1 in G such that e_1 connects D_1 and F . Then e_1 is a cut-edge of G , contradicting Claim 1. Then there are at least two edges e_i and f_i in G between D_i and F for $i \in \{1, 2\}$.

Let u_1 be the end vertex of e_1 such that u_1 is contained in F . By the planarity of G and symmetry we can choose such edges e_1 and f_1 such that the path $F[u_1, v_1]$ contains all end vertices of the edges connecting D_1 and F , but does not contain any vertices connecting D_2 and F . Let h_u and h_v be two edges in F so that the edges h_u is incident with u_1 and h_v is incident with v_1 and the two edges are not contained in $E(F[u_1, v_1])$. However F is a facial cycle so by the way we choose h_u and h_v that $\{h_u, h_v\}$ separates the vertices of D'_1 from the other part which contradicts that F does not contain a two-edge-cut. Therefore G' is connected.

So now we have that G' is connected with a maximum degree at most 3. Since F is boundary adjacent, the facial walk $\partial_i G - E(F)$ for $i = \{1, 2\}$, together with $F' - E(F)$ over all facial cycles of F' of G sharing edges with F . Hence we can see that G' satisfies the properties (1)-(4). So G' has the decomposition $\{T', M', H'\}$. However any cycles in H' and F are edge-disjoint. Hence, $H' \cup \{F\}$ is a family of edge-disjoint facial cycles in G . So G has a decomposition $\{T', M', H' \cup F\}$, a contradiction. \square

By Claim 2, every boundary-adjacent facial cycle f contains at least one 2-edge-cut S .

Claim 3. There is no two adjacent tree attachments.

Proof of Claim 3. Assume that G has two tree attachments v_1 and v_2 such that $v_1 v_2 \in E(G)$. By Claim 1, $v_1 v_2$ is not a bridge. So $G - v_1 v_2$ still satisfies the properties (1)-(4). We have that $G - v_1 v_2$ satisfies (1) since both edges incident to v_1 and v_2 , which form a cut edges are still on the boundary of G . Then $G - v_1 v_2$ satisfies (2) since v_1 and v_2 are still contained in 2-edge cuts, thus no new 2-edge cuts were created. Condition (3) is satisfied because v_1 and v_2 are new degree 2

vertices however are incident with cut-edges. Also condition (4) is true because we have not. Then $G - v_1v_2$ is smaller and therefore has a decomposition $\{T, M, H\}$. So $\{T, M \cup \{v_1v_2\}, H\}$ is a desired decomposition of G , a contradiction.

Case 1. $\partial_1 \cap \partial_2 = \emptyset$. Then every 2-edge-cut S of G satisfies that $S \subseteq E(\partial_1)$ or $S \subseteq E(\partial_2)$.

By Claim 2, a facial cycle adjacent to either ∂_1 or ∂_2 contains a 2-edge-cut. A facial cycle adjacent to both ∂_1 and ∂_2 may contain two 2-edge-cuts.

Claim 4. G has a matching M_0 such that every boundary adjacent facial cycle contains one edge in M_0 .

Proof of Claim 4. Let F be a facial cycle adjacent to ∂_1 . Then F contains a 2-edge-cut S_F . If ∂_1 contains no 2-edge-cut of F , then $S_F \subseteq E(\partial_2)$ by (2). Then F is adjacent to both ∂_1 and ∂_2 . Consider all facial cycles F adjacent to ∂_1 with a 2-edge-cut $S_F \subseteq E(\partial_1)$. Assume $S_F = \{e_1(F), e_2(F)\}$. Consider the cyclic order of these edges in these two edge-cuts on ∂_1 . Since G is a plane graph, for different two facial cycles F_1 and F_2 , S_{F_1} and S_{F_2} is not crossing the the cyclic order (i.e., appearing as $e_1(F_1)e_1(F_2)e_2(F_1)e_2(F_2)$ in the cyclic order). Then along the cyclic order of these edges, choose every other edges and let M_0^1 be the set of chosen edges.

Similarly, we can choose edges from 2-edge-cuts S_F of all facial cycles F adjacent to ∂_2 such that $S_F \subseteq E(\partial_2)$ except facial cycles F adjacent to both ∂_1 and ∂_2 and $M_0^1 \cap E(F) \neq \emptyset$. And let M_0^2 be the set of chosen edges.

Let $M_0 = M_0^1 \cup M_0^2$. Then M_0 is a matching satisfying the property. This completes the proof of Claim 4. \square

Note that $G - M_0$ satisfies (1) and (2). In the following, we are verifying that $G - M_0$ also satisfies (3) and (4). Before verify (3) and (4), we prove the following claim.

Claim 5. The boundaries ∂_i for $i = 1, 2$ does not contain a 2-edge-cut $S = \{e_1, e_2\}$ such that both e_1 and e_2 are not incident with a tree-attachment.

Proof of Claim 5. Suppose on the contrary that ∂_1 does contain a such 2-edge-cut $S = \{e_1, e_2\}$ which separates a subgraph Q and $G - Q$, where $\partial_2 \subseteq G - Q$.

Consider G/Q and add a leaf joining to the new vertex q . Let G' be the new graph. Clearly G' satisfies the properties (1)-(4). Then G' has a decomposition $\{T, M, H\}$ such that $e_1 \in M$. Note that Q has only one boundary and satisfies the properties (1)-(2) in Lemma 2.10. Then Q has a decomposition $\{T', M', H'\}$ such that both edges adjacent to e_1 in G belong to T (which could be guaranteed by Claim 4). Then $\{T \cup T', M \cup M', H \cup H'\}$ is a decomposition of G . \square

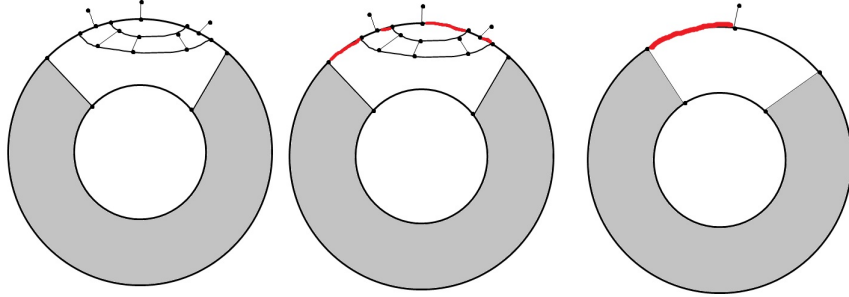

Figure 14: This is an example of how we would contract the edges and which edges belong to the matching.

By Claim 5, all 2-edge-cuts of G incident with a tree-attachment. Now, we are going to verify (3) and (4). For (3), all old degree-2 vertices still satisfy (3). Let v be a vertex such that $\deg_G(v) = 3$ but $\deg_{G-M_0}(v) = 2$. Without loss of generality, assume v is on ∂_1 . That means there is an edge e in M_0 incident with v . Let f be the ∂_1 -adjacent face containing v but not containing e . If f contains a tree attachment

on ∂_1 , then v is a degree-2 vertex incident with a cut-edge. So assume that f does not contain a tree-attachment on ∂_1 . By Claim 2, f must contain a 2-edge-cut on ∂_2 . Then M_0 must contain an edge from the 2-edge-cut. Therefore, v is on the intersection of two boundaries of $G - M_0$. This completes the verification of (3).

For (4), assume that $G - M_0$ has two boundaries intersect. If $G - M_0$ does not contain any blocks, then every face of G is adjacent to both boundaries and contains at least one tree-attachment, note that in we took care of the case if a face has two tree attachments one on each boundary. So assume we have a face f with a tree attachment on ∂_1 and a face h with a tree attachment on ∂_2 sharing an edge e . When choosing edges for M_0 let us pick the edges to the left for the tree attachments on ∂_1 and the edges to the right of each tree attachment for the tree attachments on ∂_2 . Then in $G - M_0$ we have two consecutive leaf attachments connected by e where e is not adjacent to any edge in the matching. So we can place e in the matching. Then G has a decomposition $\{T, M_0 \cup e, H\}$.

Therefore assume that $G - M_0$ satisfies (1) to (4). Then $G - M_0$ has a decomposition $\{T, M, H\}$. Note that M_0 is a matching. So $\{T, M \cup M_0, H\}$ is a decomposition of G . This completes the proof of Case 1.

Case 2. $\partial_1 \cap \partial_2 \neq \emptyset$.

If $\partial_1 \cap \partial_2$ contains two consecutive tree-attachments, let e be the edge joining them. Then $G - e$ satisfies (1) and (2) in Lemma 2.10, $G - e$ has a decomposition $\{T, M, H\}$. So G has a decomposition $\{T, M \cup \{e\}, H\}$. In the following, we assume that G contains a block.

Claim 6: A block B has more than one face.

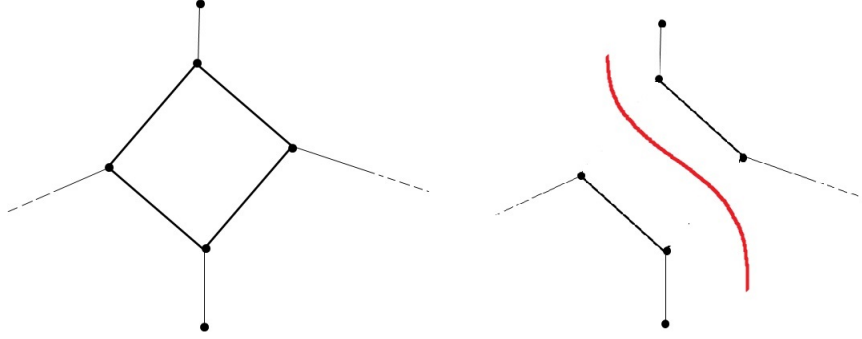

Figure 15: Example of a block with one face with and with out the matching

Proof of Claim 6: Let that G is a minimal counter example to Hoffman-Ostenhof's Conjecture and has a block B . Then assume that B has one face F . Note that since B has one face then f must be two boundary adjacent. Furthermore since G is triangle free, B has two non consecutive tree attachments u_1 and u_2 . With out loss of generality let u_1 be on ∂_1 and u_2 be on ∂_2 . Then let v_1 be the cut vertex on one side of B and v_2 the cut vertex on the other. Then we can place edge v_1u_1 and v_2u_2 in a matching M_0 . Now we have that G has a decomposition $\{T, M \cup M_0, H\}$ which is a contradiction to G be a minimal counterexample. \square

So assume that B contains more than one face by Claim 6. If B has a face f which contains a 2-edge-cut $S = \{e_1, e_2\}$ but not tree-attachments, let Q_1 and Q_2 be two components of $B - S$. Let Q'_i be the graph obtained from B by contracting Q_i into a vertex q_i and attaching a pendant edge $q_iq'_i$ to q_i . Note that both Q'_1 and Q'_2 satisfy the properties (1)-(4). As G is a minimum counterexample, both Q'_1 and Q'_2 are smaller than G , and therefore both of them have a decomposition $\{T_1, M_1, H_1\}$ and $\{T_2, M_2, H_2\}$ respectively, such that T_1 and T_2 contain e_1 , and M_1 and M_2 contain

e_2 . Then $\{(T_1 \setminus \{q'_1\}) \cup (T_2 \setminus \{q'_2\}), M_1 \cup M_2, H_1 \cup H_2\}$ is a desired decomposition of G , a contradiction. So, in the following, assume that B does not contain such faces. In other words, every boundary-adjacent face contains a tree-attachment.

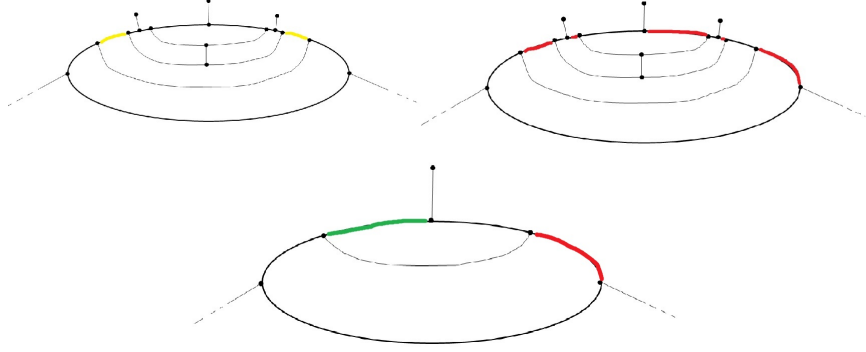

Figure 16: The yellow edges indicate the original 2-edge-cut that has no tree attachments. The red edges show the edges that are placed in the matching from Q_i . The green edge corresponds to the red edges when Q_i is contracted to Q'_1

Now suppose that B contains a non-boundary-adjacent face h . Then, by Claim 4, find a matching M_i from $\partial_i \cap B$ for $i = 1, 2$. Then $G - M_1 \cup M_2$ still contains a block with at least one face h . Note that $G - M_1 \cup M_2$ satisfies (1), (2) and (4). Note that, every face of B contains a tree-attachment. It is not hard to get that the new degree-2 vertices appears only on the face of B containing a vertex in $\partial_1 \cap \partial_2$ or if h is next to a 2-boundary-adjacent face (see Figure 15). Then the new degree-2 vertices are on the intersection of two boundaries of $G - M_1 \cup M_2$. Note that $G - M_1 \cup M_2$ is smaller and therefore has a decomposition $\{T, M, H\}$. So G has a decomposition $\{T, M \cup M_1 \cup M_2, H\}$, a contradiction.

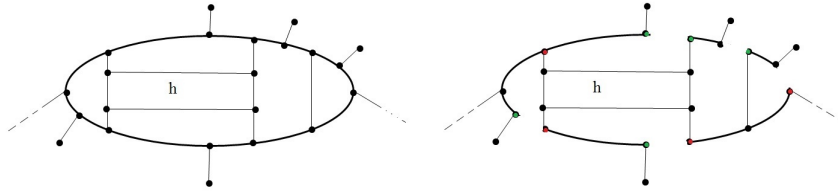

Figure 17: Here the red vertices show the new degree two vertices. Note that the green are not new degree two vertices. The green vertices indicate tree-attachments, or a chain of vertices that can be contracted to a tree-attachment.

So the only case left is that every face of B is boundary-adjacent face containing a tree-attachment.

Assume that G has all 2-boundary adjacent faces, with each face containing one leaf attachment. Then by Claim 4 we can choose a matching M along both boundaries. Let M_1 be the matching along ∂_1 and M_2 the matching along ∂_2 . Clearly $G - M$ satisfies (1)-(3). Now we need to verify (4). If all the tree attachments are on one boundary then $G - M$ now has two consecutive tree attachments (see Figure 16) so G has a decomposition.

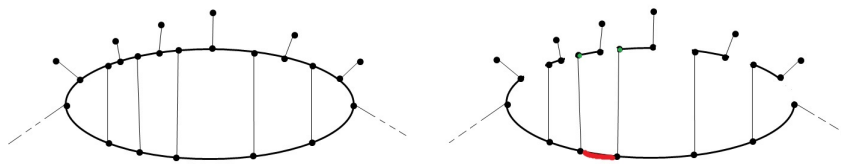

Figure 18: This graph shows an example a block with all tree-attachments on one side. The red edge indicates an edge joining two tree attachments.

Now assume there is at least one face f that has a tree attachment on ∂_2 adjacent to a face h that has a tree attachment on ∂_1 and share an edge e . Without loss of generality then we can pick M_1 such that we pick all the edges to the left of each tree attachment along ∂_1 and pick M_2 such the edges chosen are to the right of each tree attachment along ∂_2 . Then in $G - \{M_1, M_2\}$ we have two consecutive leaf attachments connected by e where e is not adjacent to any edge in the matching.

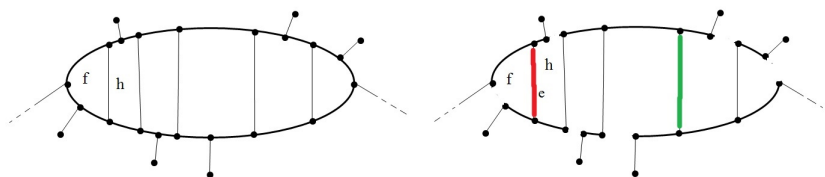

Figure 19: This is an example of a block with alternating tree attachments. The red edge is an edge connecting two tree-attachments, furthermore we can place that edge into the matching. Note that we also could have chosen the green edge.

This finishes our proof of Case 2.

This completes our proof of Lemma 2.11 □

Proof of Theorem 1.5: By Lemma 2.7 and Lemma 2.7 if we have 3-connected cubic on the torus or Klein bottle then we can find a non-separating, non-contractible cycle C such that $G - E(C)$ is a planar graph with two faces which are not bounded by cycles. Then by Lemma 2.11 G has a decomposition into a a spanning tree T , a matching M , and family of cycles H . So the proof of Theorem 1.5 is complete. □

CHAPTER 3

FUTURE RESEARCH

Now we are able to decompose a 3-connected cubic on the torus and Klein bottle into a spanning tree, a matching, and a family of cycles.

3.1 HIST Decomposition

However it might be more useful to see if we can decompose such that we get a HIST instead of just a spanning tree, or certain other subgraphs. While Douglas proved it is NP-Complete [4] to determine if a plane cubic graph has a HIST. What about cubic graphs in general? Hoffmann-Ostenhof and Ozeki [7] have been able to provide the necessary condition for existence of a HIST in cubic graphs, however could we decompose a cubic graph on the torus so that we have no degree 2 vertices in the spanning? This seems like a difficult problem given that degree 2 vertices showed up in all of our proofs for the decomposition. However the number of graphs can give this sort of decomposition should be low, considering the graph would have to have no tree-attachments when we place the graph into the plane after placing the cycle from the torus or Klein bottle into the family of cycles. If the graph did have a tree-attachment then if the graph had any 2-boundary-adjacent faces a degree 2 vertex would show up, which would be placed in the spanning tree. So that means when the graph is embedded in the plane it must have all facial cycles on the two boundaries. However even then we are not guaranteed to have no degree 2 vertices.

However this leads us to a different question, which graphs in particular can be embedded on the torus that gives us certain decomposition. While there are known limitations how can or cannot be embedded on the torus, we do not know

the decomposition of each graph. Perhaps we can get a HIST if we lowered our connectivity, or raised it.

3.2 Other Surfaces

Furthermore we could also look at embedding cubic graph into other surfaces. While there be some restrictions in the surfaces, in particular one would have be able to embed $K_{3,3}$ and be able decompose the graph such that $K_{3,3}$ would not be present when placing the decomposition into the plane. For instance $K_{3,3}$ can also be embedded in a Mobius strip, however are we guaranteed to be able to decompose it into a spanning tree, family of cycles, and a matching? Also perhaps there some surfaces which we can decompose more graphs on than others. Which in our case we are able to decompose 3-connected cubic on both the torus and Klein bottle, the torus which is orientable and the Klein bottle which is not. Could we embed more graphs on orientable surfaces that give us our desired decomposition? While there is nothing in this paper that would led us to believe so we have only looked at one of each type of surface.

We can also look at polygons. While it is well know that we can decompose a dodecahedral into a spanning tree, family of cycles, and a matching, we could look at other polygons which are almost 3-connected cubic graphs when embedded on the plane. For example a rhombic dodecahedron or trapezoid-rhombic dodecahedron. Both of which have a combination degree 2 vertics and degree 4 vertices, however perhaps we could deal with the degree 4 vertices by placing cycles into the family of cycles and force the graph down to at most degree 3 vertices. If we can a method to decompose the polygons with some degree 4 vertices, we cold extend the method to some 3-connected graphs which some degree 4 vertices.

BIBLIOGRAPHY

- [1] S. Akbari, T. Jensen, M. Siggers *Decompositions of graphs into tree, forests, and regular subgraphs*, Discrete Mathematics **338**(2015) 1322-1327
- [2] M.O. Albertson, D.M. Berman, J.P. Hutchinson and C. Thomassen, *Graphs with homeomorphically irreducible spanning trees*, J. Graph Theory **14** (1990) 247-258
- [3] J. Balogh, M. Kochol, A. Pluhar, and X. Yu, *Covering planar graphs with forest*, J. Combin Theory Ser B **94** (2005) 147-158
- [4] R.J. Douglas, *NP-completeness and degree restricted spanning trees*, Discrete Math. **105** (1992) 41-47
- [5] D. Goncalves, *Covering planar graphs with forest, one having bounded maximum degree*, J. Combin Theory Ser B **99** (2009) 314-322
- [6] A. Hoffmann-Ostenhof, *Nowhere-zero flows and structures in cubic graphs*, Ph.D. Dissertation, Universitat Wien, (2011)
- [7] A. Hoffmann-Ostenhof, and Kenta Ozeki, *On HIST in Cubic Graphs*, (2015)
- [8] A. Kostochka, *Spanning trees in 3-regular graphs*, REGS in Combinatorics, University of Illinois at Urbana-Champaign, (2009)
- [9] P. Lemke, *The Maximum Leaf Spanning Problem for Cubic Problems is NP-Complete*, Retrieved from the University of Minnesota Digital Conservancy, (1988)
- [10] J. Malkevitch, *Spanning tress in polytopal graphs*, Ann. New York Acad. Sci. **319** (1979) 362-367

- [11] G. Mazzucolo, *New conjectures on perfect matching in cubic graphs*, Electron. Notes Discrete Math **40** (2013) 235-238
- [12] M. Montassier, P. Ossona de Mendez, A. Raspaud, and X. Zhu, *Decomposing a graph into forests*, J. Combin. Theory Ser B **102** (1) (2012) 38-52
- [13] K. Ozeki and D. Ye, *Decomposing plane cubic graphs*, European Journal of Combinatorics, to appear.
- [14] C. Thomassen, *Reflections on Graph Theory*, J. Graph Theory **10** (1986) 309-324
- [15] C. Thomassen, *A theorem on paths in planar graphs*, J. Graph Theory, **7** (1983) 169-176
- [16] R. Richter and R.P. Vitray, *On Essential and Inessential Polygons in Embedded Graphs*, Journal of Combinatorial Theory, **84** (2002) 100-117